

NVS-10790040BS



Weatherproof Column Speaker 40W



Column Speaker

DESCRIPTION

NVS-10790040BS is an weatherproof column speaker with built-in amplifier of 70V/100V. this transformer technique reduces line losses on longer distance and allows easy parallel connection of multiple loudspeakers. The products have gotten waterproof technology, and the net cover is made of aluminum and would not affect rusting. The speaker is designed with dual-crossover. It can be applied to different occasions vary in area sizes and background noises, such as stations, open parks, schools, mall, industrial park etc.

FEATURES

- ◉ Waterproof level of IPX6
- ◉ Weatherproof column type Speaker
- ◉ Aluminum enclosure & grille
- ◉ High sensitivity
- ◉ Wide Frequency Response

Specifications	
Model	NVS-10790040BS
Rated Power	40W
Driver Unit	4"×4,2.5"×1
Frequency Response	140Hz-14kHz
Input Voltage/Impedance	70V/100V
Sensitivity(1m,1w)	93dB±2dB
Maximum SPL(1m)	109dB±2dB
Coverage angle(HxV)	210°×80°
Input Connector	Two-wire cable
Operating temperature	-25°C~+60°C
Weight	5.5kg
Dimension	120×160×610mm

NVS-10790040BS

Weatherproof Column Speaker 40W

DIMENSION

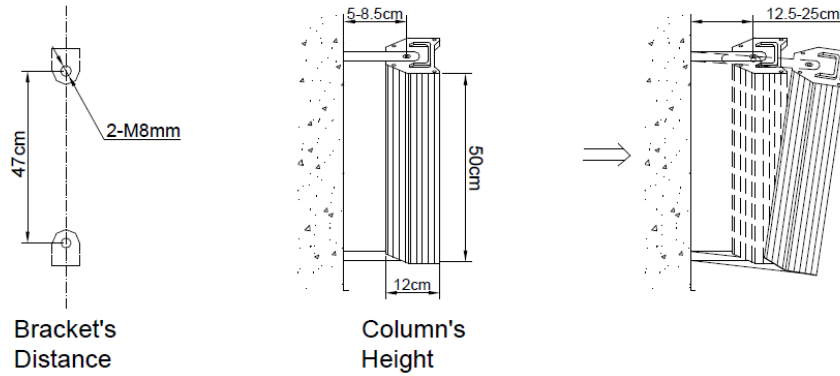

ORDERING INFORMATION

Part Number	Description	Standard Quantity
NVS-10790040BS	Weatherproof Column Speaker 40W	01

ACCESSORIES INFORMATION

Description	Standard Quantity
05 Hanger big bend piece	01
05 Hanger small curved piece	01
05 Hanger straight piece	01
8x14 Hexagonal wire	04
18 Hexagonal nuts	02